

FLOOR LAMPS



AR1
ABRAHAM & ROL
1965



B4
R.J. CAILLETTE
1957



RF503
R. FATUS
1957



J14
J.A. MOTTE
1959



A23
A. RICHARD
1968

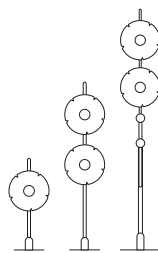

2983 /80 - 150 - 225
O. MOURGUE
1969

TABLE LAMPS



1013
P. DISDEROT
1955



1021
R. FATUS
1960



J13
J.A. MOTTE
1959



F170
E. FERMIGIER
1970



A22
A. RICHARD
1960



A21
A. RICHARD
1960



AR71
ABRAHAM & ROL
1964

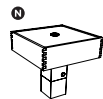

AR70
ABRAHAM & ROL
1964



AR65
ABRAHAM & ROL
1965



WATT
S. DUBUISSON
2019

WALL LAMPS



2059
P. DISDEROT
1955



B3
R.J. CAILLETTE
1957



2093-A
O. MOURGUE
1969



6135PM
P. PAULIN
1960



6135GM
P. PAULIN
1960



5980
A. RICHARD
1957



A25
A. RICHARD
1968



A25-190
A. RICHARD
1968



A25-270
A. RICHARD
1968



A24-1500-D
A. RICHARD
1968

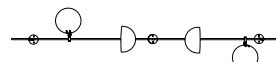

A24-2200-Q
A. RICHARD
1968

PENDANT & CEILING LAMPS

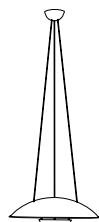

M4
M. MORTIER
1952



B5
R.J. CAILLETTE
1957



A25-270-D
A. RICHARD
1968



A26
A. RICHARD
1968



2983 /S
O. MOURGUE
1969

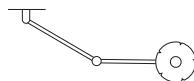

2093-BO
O. MOURGUE
1969



DISDEROT LAMPE À POSER 1021 ROGER FATUS

INSTRUCTIONS DIRECTIONS FOR USE



LAMPE À POSER 1021 1960

Avec cette lampe très simple, ultra légère qui se déplace facilement, Roger Fatus invente l'avant-garde du luminaire des années 60. Il met au point une proportion parfaite et une forme inédite qui allient subtilement symétrie et asymétrie pour dessiner dans un même mouvement poignée et piètement. Le plexiglas, tout nouveau à la fin des années 50, transforme la notion classique d'abat-jour et donne à cette lampe d'ambiance son caractère intemporel, aujourd'hui encore....

This minimalist, ultra-light lamp that can be moved easily reflects the avant-garde design created by Roger Fatus in the nineteen sixties. The Fatus design creates a perfect size and shape, subtly blending symmetrical and asymmetrical lines in the handle and base. The use of plexiglas, brand new at the end of the fifties, transforms the classic design of lampshade and gives this ambient lamp its timeless character, even today....

DISDEROT • 03/2021 • FATUS • 1021

N Nouveautés, *New editions* Disderot 2021



DISDEROT
Passage Saint-Paul • 75004 Paris
832 051 346 RCS PARIS
www.disderot.com

Retrouvez l'ensemble
des modèles sur
www.disderot.com





ROGER FATUS
1926

Formé à l'École Nationale Supérieure des Arts Décoratifs, Roger Fatus apprend son métier auprès du très chic décorateur Jacques Dumond. Il ouvre ensuite son agence Rue Madame à Paris comme designer et architecte d'intérieur. Il édite ses meubles chez Sentou et ses luminaires chez Disderot. Son style moderne et rigoureux inspiré de l'Union des Artistes Modernes lui apporte de nombreux prix et la reconnaissance. Il enseigne à l'ENSAD et dirige l'école Camondo de 1982 à 1989.

Trained at the National School of Decorative Arts, Roger Fatus learnt his skills from the chic decorator Jacques Dumond. He then opened his gallery in Rue Madame in Paris, as a designer and interior designer. He sold his furniture at Sentou and his lights at Disderot. His modern and rigorous style was inspired by the Union of Modern Artists and brought him many awards and widespread acclaim. He was a teacher at ENSAD and directed the Camondo School from 1982 to 1989.

INSTRUCTIONS DIRECTIONS FOR USE

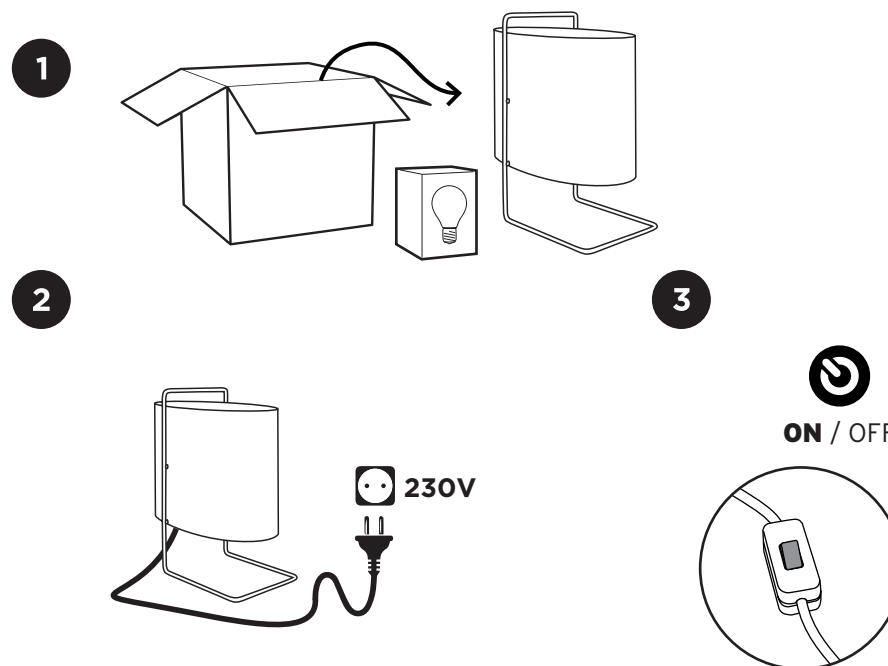

LAMPE À POSER 1021

DONNÉES TECHNIQUES, TECHNICAL DATA

ROGER FATUS,
1960

Finitions

Chrome - plexiglass blanc, Chrome, white plexiglass
Chrome, plexiglass blanc
Chrome, white plexiglass

Références

1021-ch

Sur mesure nous consulter, Custom-made contact us

LED 5W 590Lm / 2700K / E27 CE IP 20 220-240V
Chrome, plexiglass blanc
Chrome, white plexiglass

Poids, Weight
0,8 Kg

Édition numérotée, Umbered Edition,
Délivrée avec certificat d'authenticité, Delivered with authentication certificate,
Fabriqué en France, Made in France.

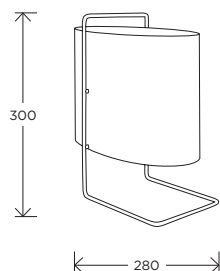

INSTALLATION 1 Sortir le luminaire de sa boîte en prenant soin de ne pas l'endommager. 2 Brancher le luminaire dans une prise électrique appropriée, 230 V. 3 Allumer le luminaire.

INSTALLATION 1 Remove the lamp from its box, taking care not to damage it. 2 Connect the lamp to a suitable electrical outlet, 230 V. 3 Switch on the lamp.

INSTRUCTION POUR LE NETTOYAGE

Pour le nettoyage de l'appareil utiliser exclusivement un chiffon doux, humecté si nécessaire, avec de l'eau et du savon.

⚠ **Attention** : ne pas utiliser d'alcool ou solvants.

CLEANING INSTRUCTION

Use only a soft cloth to clean the appliance, dampened with water and soap.

⚠ **Warning**: do not use alcohol or other solvents.



Ne jetez pas ce luminaire. Cet appareil contient des composants recyclables. Veuillez consulter les informations de votre commune concernant le ramassage des déchets électriques. Si ce luminaire comprend une ampoule ne la mettez pas non plus à la poubelle, veuillez la retourner à votre point de vente ou un centre de ramassage approprié.

This product contains recyclable components. Please recycle the lamp and bulb responsibly in accordance with your local recycling guidelines or services for electrical products.